

Animation principles

Reading

Required:

- ◆ John Lasseter. Principles of traditional animation applied to 3D computer animation. Proceedings of SIGGRAPH (Computer Graphics) 21(4): 35-44, July 1987.

Recommended:

- ◆ Frank Thomas and Ollie Johnston, Disney animation: The Illusion of Life, Hyperion, 1981.

Character animation

Goal: make characters that move in a convincing way to communicate personality and mood.

Walt Disney developed a number of principles.

Computer graphics animators have adapted them to 3D animation.

Question: What are the reasons that **you** should learn about these techniques?

Animation Principles

The following are a set of principles to keep in mind:

1. Squash and stretch
2. Staging
3. Timing
4. Anticipation
5. Follow through
6. Overlapping action
7. Secondary action
8. Straight-ahead vs. pose-to-pose vs. blocking
9. Arcs
10. Slow in, slow out
11. Exaggeration
12. Appeal

We will consider each...

Squash and stretch

Squash: flatten an object or character by pressure or by its own power.

Stretch: used to increase the sense of speed and emphasize the squash by contrast.

Note: keep volume constant!

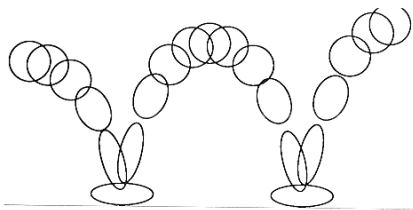

FIGURE 2. Squash & stretch in bouncing ball.

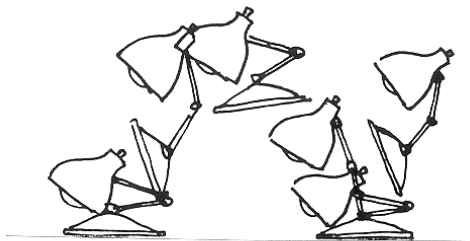

FIGURE 3. Squash & stretch in Luxo Jr.'s hop.

Squash and stretch (cont'd)

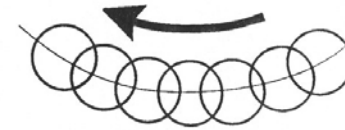

FIGURE 4a. In slow action, an object's position overlaps from frame to frame which gives the action a smooth appearance to the eye.

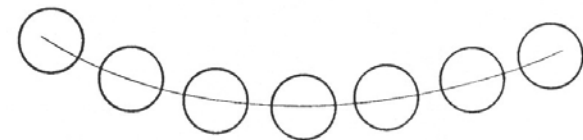

FIGURE 4b. Strobing occurs in a faster action when the object's positions do not overlap and the eye perceives separate images.

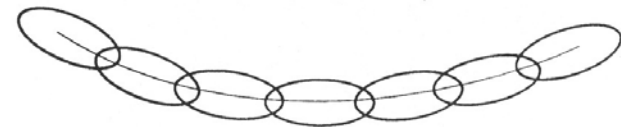
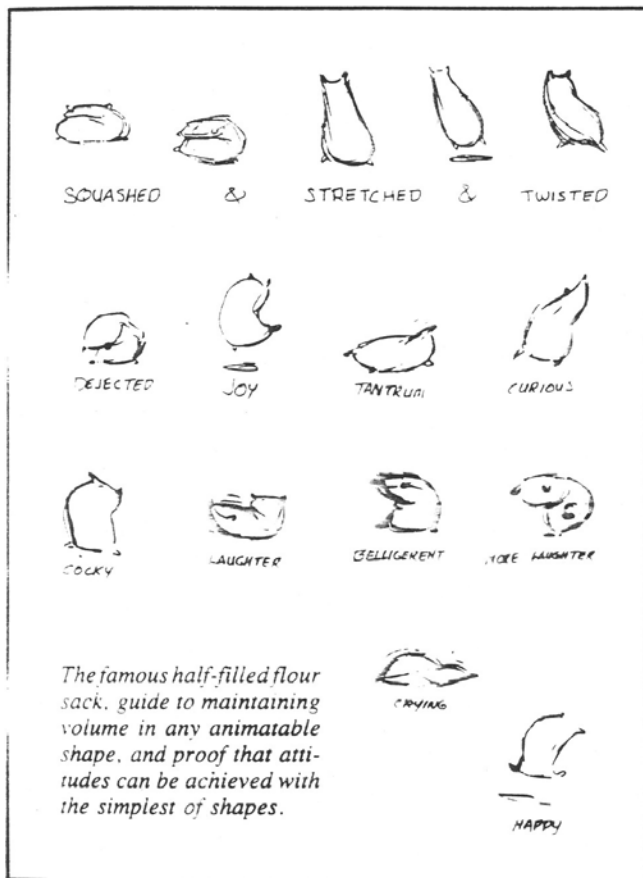

FIGURE 4c. Stretching the object so that its positions overlap again will relieve the strobing effect.

Squash and stretch (cont'd)



Varying squash and stretch

Three versions of gesture showing determination.
(Lift chest with one hand in front).

Minimal squash/stretch: (boring)

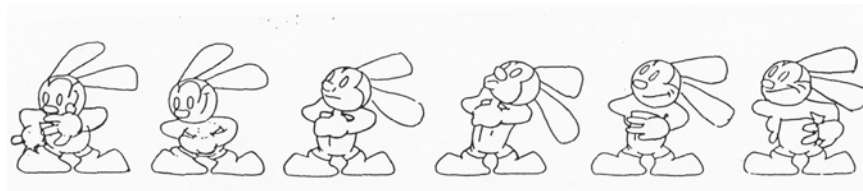

Medium squash/stretch: (lively character)



Extreme squash/stretch: (comical)



Squash and stretch (cont'd)

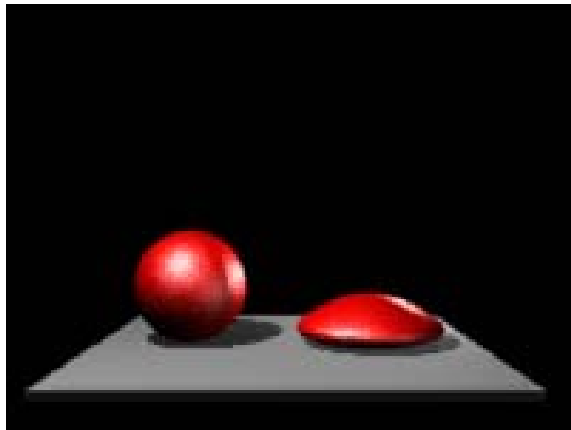

Staging

Present the idea so it is unmistakably clear.

Audience can only see one thing at a time.

Useful guide: stage actions in silhouette.

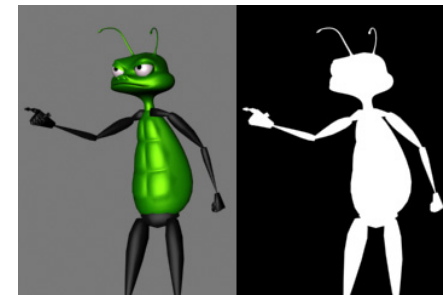
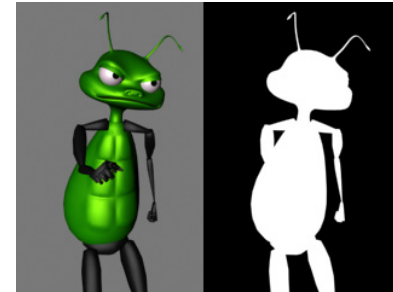

In dialogue, characters face 3/4 towards the camera, not right at each other.

Timing

An action generally consists of anticipation, the action, and the reaction. Don't dwell too long on any of these.

Timing also reflects the weight of an object:

- ◆ light objects move quickly
- ◆ heavier objects move more slowly

Timing can completely change the meaning of an action.

Timing (cont'd)

The many meanings of a simple head turn:

NO inbetweens	hit by a tremendous force.
ONE inbetween	hit by a brick, frying pan.
TWO inbetweens	nervous tic, muscle spasm.
THREE inbetweens	dodging a thrown brick.
FOUR inbetweens	giving a crisp order (move it!)
FIVE inbetweens	a more friendly order (c'mon!)
SIX inbetweens	sees a sportscar he always wanted
SEVEN inbetweens	trying to get a better look...
EIGHT inbetweens	searching for something on shelf
NINE inbetweens	considering thoughtfully
TEN inbetweens	stretching a sore muscle

Anticipation

An action has three parts: anticipation, action, reaction.

Anatomical motivation: a muscle must extend before it can contract.



Prepares audience for action so they know what to expect.

Directs audience's attention.

Anticipation (cont'd)

Amount of anticipation (combined with timing) can affect perception of speed or weight.



Follow through

Actions seldom come to an abrupt stop.

Physical motivation: inertia

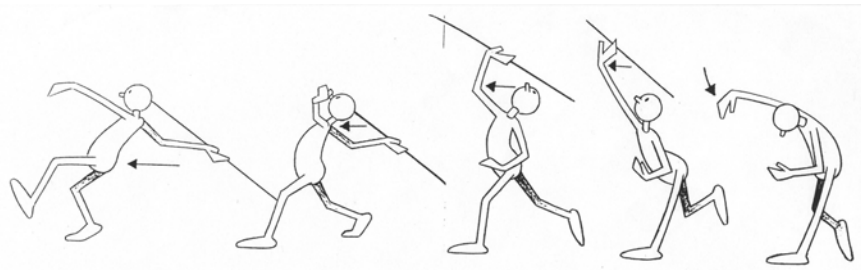

Follow through (cont'd)

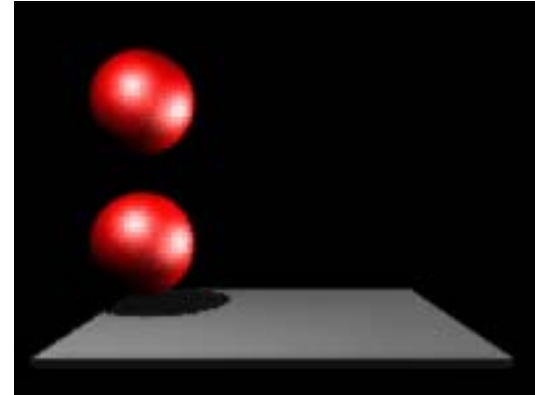

Overlapping and secondary action

Overlapping action

One part initiates ("leads") the move. Others follow in turn.

Hip leads legs, but eyes often lead the head.

Loose parts move slower and drag behind.

Overlaps apply to intentions. Example: settling into the house at night.

- ◆ Close the door
- ◆ Lock the door
- ◆ Take off the coat
- ◆ etc...

Each action doesn't come to a complete finish before the next starts.

Secondary action

An action that emphasizes the main point but is secondary to it.

Straight-ahead vs. pose-to-pose vs. blocking

Straight ahead: proceed from frame to frame without planning where you want to be in ten frames. Can be wild, spontaneous.

Pose-to-pose: Define keyframes and "inbetweens".

Blocking:

- ◆ Start key-framing at the top of the transform hierarchy.
- ◆ Refine level by level.
- ◆ Keyframes for different parts need not happen at the same time.

Arcs

Avoid straight lines since most things in nature move in arcs.

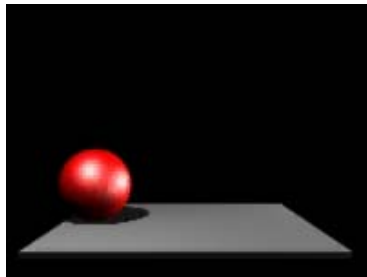
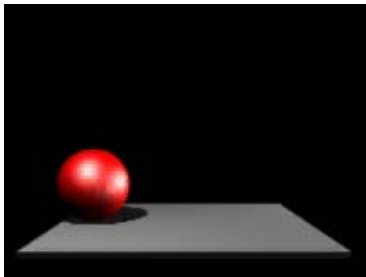

Slow in and slow out

An extreme pose can be emphasized by slowing down as you get to it (and as you leave it).

In practice, many things do not move abruptly but start and stop gradually.

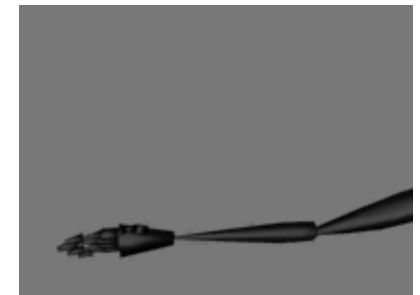
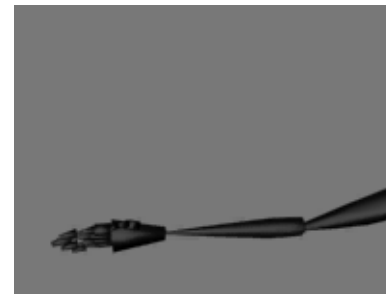
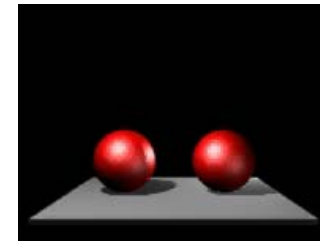

Exaggeration

Get to the heart of the idea and emphasize it so the audience can see it.



Appeal

The character must interest the viewer.

It doesn't have to be cute and cuddly.

Design, simplicity, behavior all affect appeal.

Example: Luxo, Jr. is made to appear childlike.

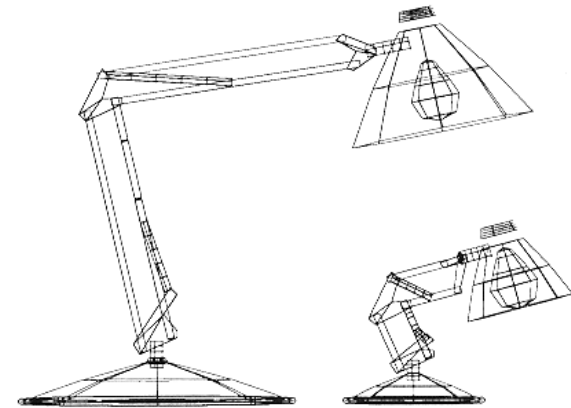
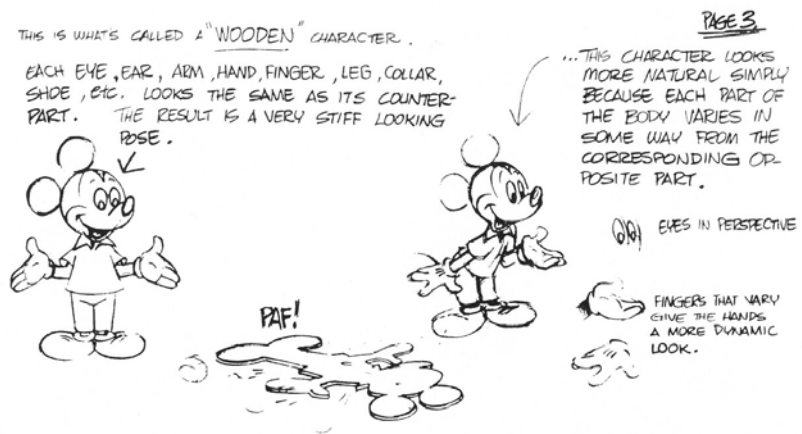

FIGURE 11. Varying the scale of different parts of Dad created the child-like proportions of Luxo Jr.

Appeal (cont'd)

Note: avoid perfect symmetries.



23

Appeal (cont'd)

Note: avoid perfect symmetries.



24

Animation artifact

Animation artifact

- ◆ Absolute time limit: **40 seconds**...shorter is better!!!
- ◆ Artifacts due by **11:59pm Monday Nov 7**

Current Trends in Animation

Current trends in animation

Current trends in animation:

- ◆ Geometric modeling and instrumentation
- ◆ Realistic rendering – not just ‘cartoons’
- ◆ Physical simulation
- ◆ Controllable simulation
- ◆ Digital humans

Geometric modeling and instrumentation

Building characters with the right shape and control points is time consuming..

Want the “right” set of controls

- ◆ Control points
- ◆ Muscle groups
- ◆ Blending example expressions
- ◆ “Instrumentation” controls



Realistic rendering

Research in rendering materials accurately is ongoing.

Recent progress in Bi-directional Subsurface Scattering Distribution Functions (BSSRDF's) is changing the look of everyday things...and skin.

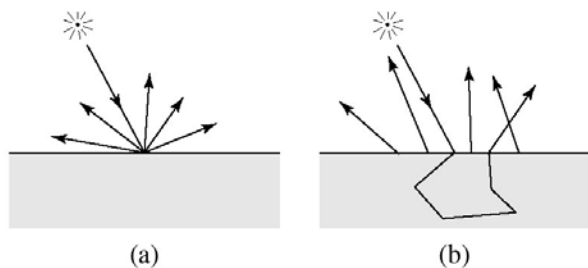

Figure 1: Scattering of light in (a) a BRDF, and (b) a BSSRDF.



Realistic rendering (cont'd)



Physical simulation

Some effects are too difficult to model by hand (fire, snow, steam, rustling trees, hair, cloth, etc.)

Can do simulation (both physical and non-physical)

- ◆ Particle systems
- ◆ Fluid flow and turbulence modeling
- ◆ Rigid body dynamics
- ◆ ...



Physical simulation (cont'd)



Controllable simulation

Want to have some interactive control.

Example: insert cloth wrinkle here.

- ◆ How do you merge this with the physical simulation without starting over?

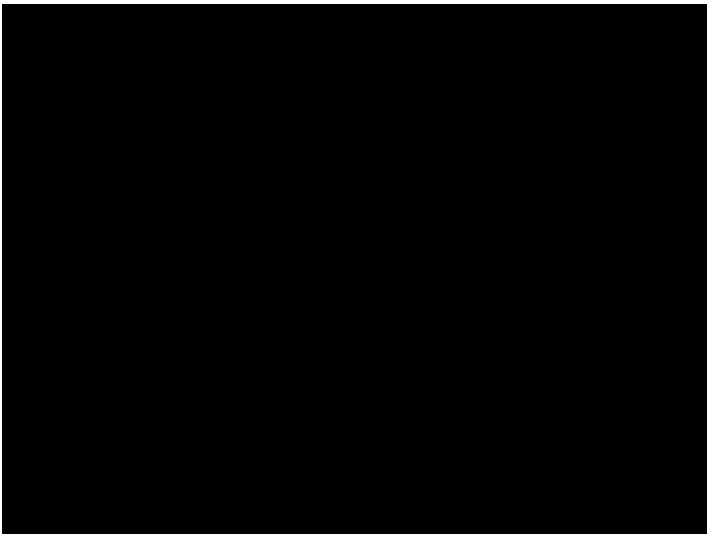

Controllable simulation

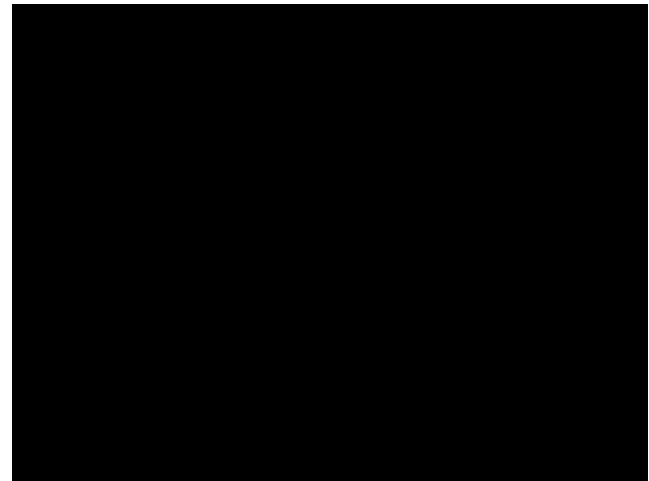
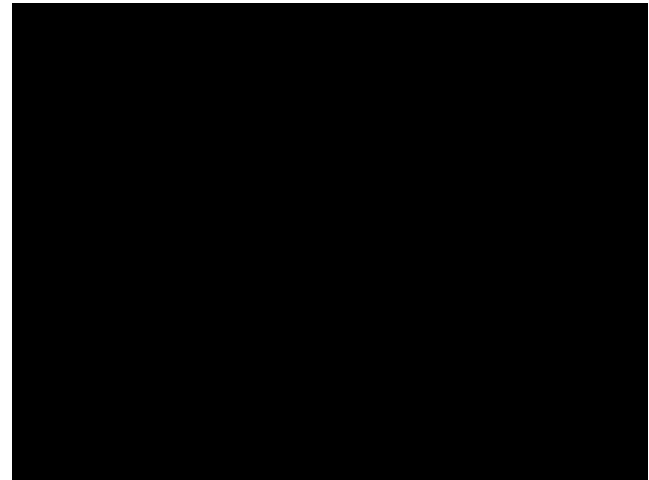

Controllable simulation

Controlling fluids

- ◆ [Bunny](#)
- ◆ [Bunny reloaded](#)
- ◆ [Boxing](#)
- ◆ [Running](#)
- ◆ [Running again](#)
- ◆ [Running water](#)
- ◆ [Running water again](#)

Simulation for secondary motion

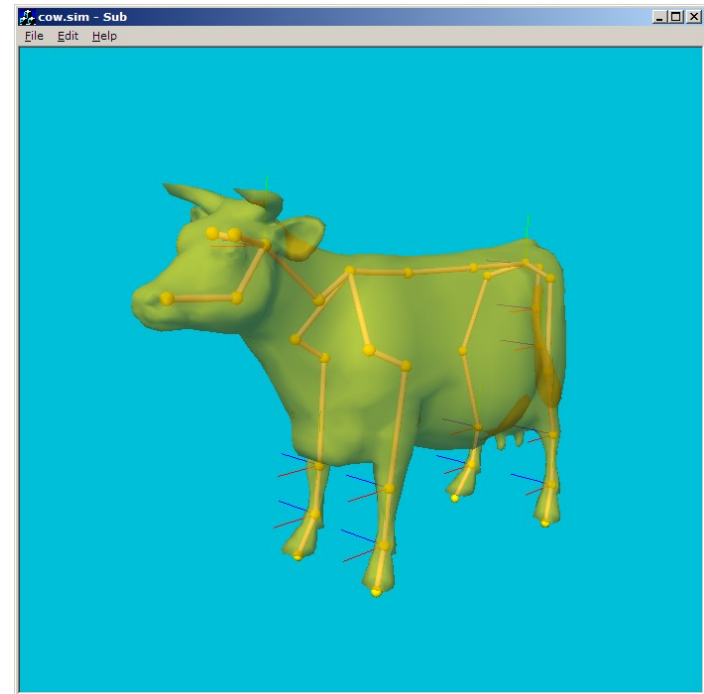

Digital humans

Making realistic human bodies and faces and animating them manually is really hard.

What could we do instead?

- Capture real human motion
- Capture real human shapes
- Use them “as-is”, or modify/retarget them

Digital humans: motion capture

Motion capture techniques:

- ◆ Special sensors for joint angles/positions
 - wires get in the way
- ◆ Unassisted computer vision
 - Typically not accurate enough
- ◆ Assisted computer vision (add markers)
 - Have to handle occlusions

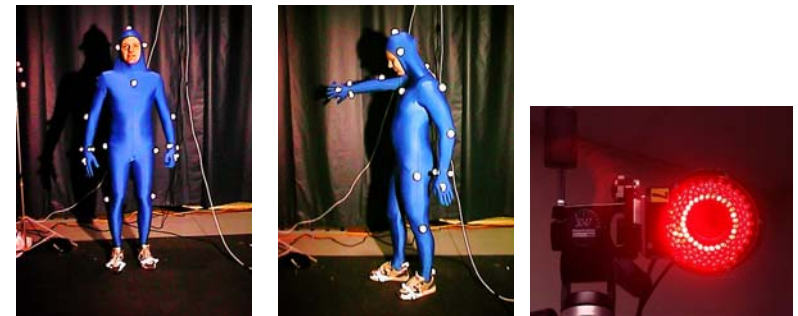

Motion processing

- ◆ Motion data is often noisy → filter it with smoothing filter.
- ◆ Can apply a variety of filters
- ◆ “Re-targeting” motion is challenging

Digital humans: body shape modeling



Digital humans: body shape modeling

**Articulated Body Deformation
from Range Scan Data**

Digital humans: body shape modeling

The space of human body shapes:
reconstruction and parameterization
from range scans

Brett Allen
Brian Curless
Zoran Popović

Demo

Digital humans: facial animation

One goal: performance driven facial animation

- ◆ animator makes faces
- ◆ video camera watches
- ◆ computer processes in real time
- ◆ character's face comes to life
- ◆ animators are actors!!

Digital humans: facial animation

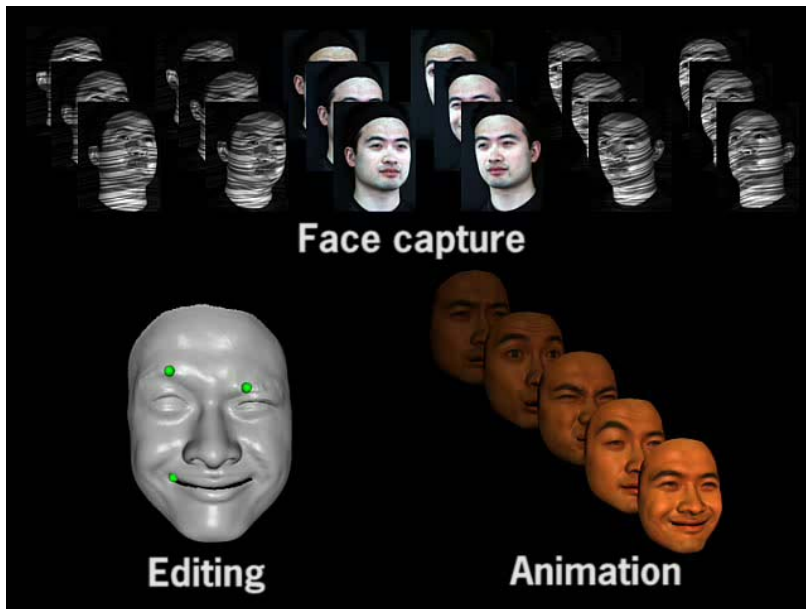

Digital humans: facial animation



Digital humans: facial animation



Digital humans: facial animation



Summary

Goals:

- Realism
 - * Of geometric models
 - * Of animations
- Controllability
 - ... but at a “high” level
 - * ability to achieve specific outcomes
- High productivity for artists
 - * do as much automatically as possible

Underlying approach:

- Mathematical model of e.g. facial motion
- Parameters determined from captured data

Some relevant mathematical tools:

- Fitting of data to mathematical models
(a form of optimization)
- Solving “inverse” problems

Next class: Parametric surfaces

Topic:

How do we mathematically represent surfaces?

Read:

- Watt, 2.1.4, 3.4-3.5.

Optional:

- Watt, 3.6.
- Bartels, Beatty, and Barsky. An Introduction to Splines for use in Computer Graphics and Geometric Modeling, 1987.
[Course reader, pp. 239-247]